



YLI ELECTRONIC



Extended Wall Mount Door Holder

Model:YD-602

Basic Instruction

Dual Voltage Selectable(12VDC or 24VDC)
Emergency Release Button/Test Button
Wall Mounting Direction

Low Current Consumption
Reliable Fail-Safe Mechanism
Durable and Silence Operation

Specifications

- Size: 80Lx80Wx103H(mm)
- Voltage: 12/24VDC(Adjustment)
- Current Draw: 12V/140mA 24V/70mA
- Optional: Manual door release button
- Surface Temp: $\leq +20^{\circ}\text{C}$
- Operating Temp: $-10\sim+55^{\circ}\text{C}$ (14-131F)
- Weight: 1.0kg

- Holding Force: 50kg(110Lbs)
- Suitable for: All Kinds of Single(Double) Smokeproof Doors
- Suitable Humidity: 0~95%
- Finishes for Shell: High Temperature Paint Environmental Protection Zinc
- Finishes for Armature: Chromium

Dimension

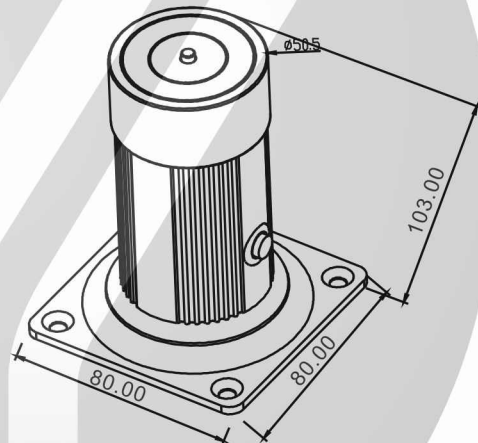
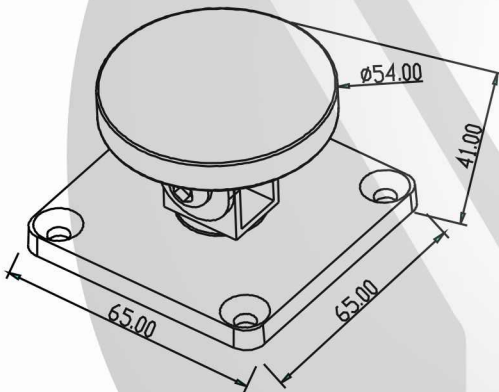

Installation

12/24V Adjustable

Remarks:

1. The default setting is 24VDC.
2. If user want to connect with 12VDC, operating as below:
 - (1) Pull those two jumpers out. It is showed 4 pins here.
 - (2) To set up 12VDC, insert one jumper on the position of 1 and 2, second jumper on the position of 3 and 4.

